

WHITE  
PAPER

)4

## Guide on how to choose a professional desktop 3d printer

---

# Table of contents

---

01

**3D Printing and FFF: An Introduction**

Page 3

---

02

**3D Printing Basic Concepts**

Page 4

2.1 Introduction

2.2 Build volume

2.3 Best layer resolution

2.4 Hotends

2.5 Extruders

2.6 Dual Extrusion

2.7 Printing Speed

2.8 Compatible Materials

2.9 Print Surface

2.10 Firmware

2.11 Slicing Software

---

03

**Conclusion**

Page 17

---

# 01

## 3D Printing and FFF: An Introduction

---

3D Printing Technology, a process also known as Additive Manufacturing (AM), or Rapid Prototyping, is a manufacturing process where layers of material are built up to create a solid 3D object.

Plastic is the most popular material used in desktop 3D printing, and the most popular process used to print with plastic is Fused Deposition Modeling (FFF). FFF is an extrusion process in which the object is built by depositing melted material layer-by-layer. The plastics used in this process correspond to the same thermoplastics that can be found in conventional manufacturing processes, such as ABS or Nylon.

The business world has shown an incessant interest in incorporating 3D printing technologies into their workflow. Reduction in costs and time have validated the industrial usability for a technology created to deliver customized objects. This has made the Additive Manufacturing market prone to competition and the options available for businesses are endless. We have developed this White Paper to help you identify the key features that will allow your team to identify the right 3D printer based on your company's needs, goals and requirements. Up next is a thorough coverage of 3D printing basics – we hope that this guide will cover all your 3D printing questions!

# 02







# 3D Printing Basic Concepts

## 2.1 Introduction

Whether you are just discovering the world of 3D printing or you are familiar with 3D printers, it is recommended to check on industry updates and see the different machines available, and their offers and options. These are the 10 most important properties you should evaluate and compare when buying a 3D printer:

<b>Build Volume</b>	<p>Maximum size of a model that a 3D printer can produce in a single print. Build volume is one of the most important indicators when selecting a 3D printer.</p> <ul style="list-style-type: none"><li>• <i>Select a low or regular build volume if you are printing regular size pieces. Most 3D printer users don't need a large build volume.</i></li><li>• <i>Select a large build volume if you are planning on printing large volume pieces.</i></li></ul>
<b>Best Layer Resolution</b>	<p>Distance between one layer and the next one. The layer resolution determines the quality on the Z-axis.</p> <ul style="list-style-type: none"><li>• <i>If you are aiming at high resolution, select a smaller height between layers.</i></li><li>• <i>If you are aiming at speed, select the widest height.</i></li></ul>
<b>Hotend</b>	<p>Component of an FFF 3D printer that heats, melts and extrudes the material layer by layer through a nozzle.</p> <ul style="list-style-type: none"><li>• <i>If you are aiming at high resolution, select a smaller nozzle size.</i></li><li>• <i>If you are aiming at homogeneous printing, select a hotend made of good components, as this will ensure even heat distribution.</i></li></ul>
<b>Extruder</b>	<p>Motor and all the associated mechanisms that push and pull the filament to carry it from the spool to the hotend.</p> <ul style="list-style-type: none"><li>• <i>If you are aiming at high resolution, select a smaller nozzle size.</i></li><li>• <i>If you are aiming at homogeneous printing, select a hotend made of good components, as this will ensure even heat distribution.</i></li></ul>

## 3D Printing Basic Concepts

<p><b>Dual Extrusion</b></p>	<p>Ability of an FFF 3D printer to use two different filaments in a single print job.</p> <p> • If you are aiming at simple prints, then select a parallel dual extruder. • If you are aiming at using multi-materials creations with a clean execution, then select a machine with IDEX system.</p>
<p><b>Printing Speed</b></p>	<p>Speed of the print head at which the deposition of molten material occurs.</p> <p> • If you would like to obtain quick renderings, then select higher printing speeds. • If you would like to achieve higher quality on your printed pieces, then select lower printing speeds.</p>
<p><b>Compatible Materials</b></p>	<p>Filament that would be printable in a determined machine. FFF 3D Printers accept a wide range of thermoplastic materials.</p> <p> • You will have more 3D printer options available if you are planning to print only with PLA. • If you are planning on using a wide range of materials, then you will find fewer options in the market.</p>
<p><b>Print Surface</b></p>	<p>The surface in which the first layer of a print job adheres.</p> <p> You can choose the temperature and materials of your print surface: • If you are looking to prevent warping, use a heated surface, as well as adhesive or highly adhesive surfaces.</p>
<p><b>Firmware</b></p>	<p>Permanent software loaded into the 3D printer. It controls the electronic circuits of it.</p> <p> • If you are a beginner user, it is easier to manipulate an intuitive firmware. • If you are familiar with 3D printing machines, then a more complex firmware will give you greater control over the machine and the ability to further tailor your prints.</p>
<p><b>Slicing Software</b></p>	<p>Computer software used in FFF 3D printing processes for the conversion of a 3D object model into a specific set of instructions for the printer.</p> <p> • If you select a 3D printer that comes with its own slicing software, then the set up will be a little easier since you will have pre-loaded specifications appropriate for that printer model.</p>

## 3D Printing Basic Concepts

### 2.2 Build volume

#### What is build volume?

The build volume is the maximum size of a model that a certain 3D printer can produce in a single print, and it is one of the most important indicators to look at when selecting a 3D printer.

#### How does the build volume affect the printer?

If the size of the part is higher than the build volume, the piece will have to be printed in separate parts and assembled in post-production.

Similarly, if the model has mechanical movement, the parts must be printed out separately and assembled in post-production.

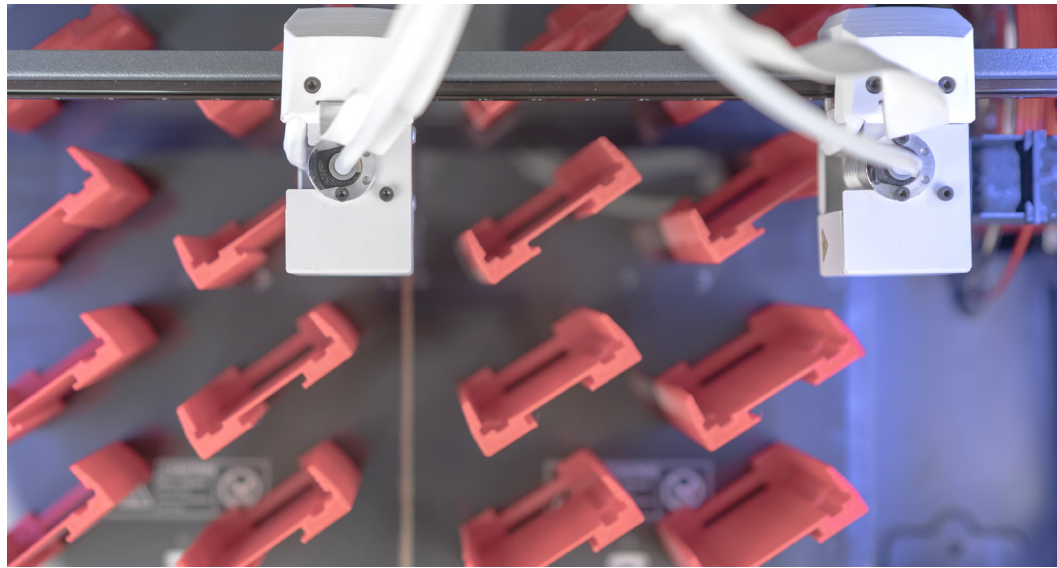

#### Which build volume may fit you better?

As the build volume indicates the maximum size of a print, the build volume will be an important indicator when selecting a printer. If the business need is to print large volume pieces, the company will have to select a printer with a large build volume. The versatility to produce large objects may generate a loss in accuracy and reliability.

## 2.3 Best layer resolution

### What is the layer resolution?

The layer height is the distance between one layer and the next one. The layer resolution determines the quality on the Z-axis.



### What influence has in the printer?

There is a wide range of layer heights in the market. Using lower layer heights, the printer ensures the Z-axis is well-defined and that planes with curvatures will have a smooth surface. Alternatively, larger layer heights will print out models faster, reducing the resolution.

### Which layer resolution may fit you better?

The typical range of layer heights goes from 0.05mm to 0.5mm. This range is important when deciding which printer may fit your business better, as not all machines will print within the full range of layer heights.

Here you can find a table comparing layer height with print requirements:

Choosing the adequate Layer Height		
 0.05mm to 0.15mm	 0.15mm to 0.25mm	 0.25mm to 0.50mm
High quality	Standard quality	Draft quality
<ul style="list-style-type: none"><li>• Intricate parts, models with curved surfaces and holes.</li><li>• Parts for visual appearance.</li><li>• Parts that do not require post-processing before use.</li></ul>	<ul style="list-style-type: none"><li>• Versatile.</li><li>• Most pieces will be printed in this range.</li></ul>	<ul style="list-style-type: none"><li>• Fast prints where the importance resides on the functionality.</li><li>• Parts that are going to be post-processed.</li></ul>

As each layer height requires a specific flow from the hotend, not all of them are printable with only a single nozzle. Lowest layer heights are done with small nozzles, which are the ones with less flow capability. That means that it is important to check which nozzles are compatible with the machine and the ease of swapping them.

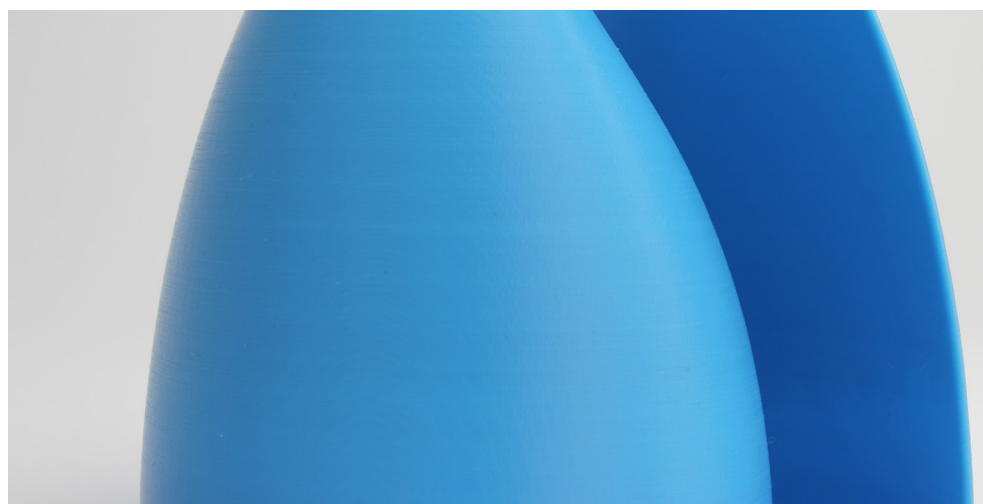

### 2.4 Hotends

#### What is the hotend?

The hotend is the component of an FFF 3D printer that heats, melts and extrudes the material layer by layer through a nozzle.

#### What influence has in the printer?

The hotend determines the range of compatible materials with which the machine prints an object. The size of the nozzle defines the resolution on the plane X/Y. There are different types of hotends and nozzle sizes. Regular and most popular nozzle sizes range from 0.2mm to 1mm in diameter.

Hotends have an important impact on the final print and machine reliability. As a general rule, the better the quality of the components of the hotend, the better will be the heat transfer through the printing material. This will result in a homogenous printing temperature and excellent heat dissipation.

You can learn more about the parameters governing the definition of hotends in our 'Anatomy of an Extrusion System' – [here](#).



#### Which hotend may fit you better?

Since most printers accept different hotends and nozzle sizes, the important feature to check on the printer specs is how easy it is to swap hotends. Users should also make sure that the materials they want to use are printable with the compatible hotends. For example, if you are planning to print with Polycarbonate, PEEK hotends are not compatible as they would be affected by the high temperatures. Finally, it is important to check that hotends are produced by reliable manufacturers to ensure the best printing quality and durability.





## 2.5 Extruders

### What is the extruder?

An extruder is a motor and all the associated mechanisms that push and pull the filament to carry it from the spool to the hotend.

### What influence has in the printer?

The extruder determines the amount of material feeding the hotend. Therefore, having a high-performance extruder avoids under-extrusion problems and grinding filament problems. There are two types extruders, direct and bowden:

Types of Extruders	
 <p><b>Direct Extrusion</b></p>	 <p><b>Bowden Extrusion</b></p>
<p>Direct extrusion is a method of extrusion that inserts the filament directly into the hot end. The extruder pushes the filament directly into the nozzle, where it is softened to later emerge as a precise extrusion line.</p>	<p>The Bowden extruder grasps the filament and pushes the filament through a long PTFE Bowden tube and into the hot end. The extrusion motor is physically separated from the printer's frame.</p>
<ul style="list-style-type: none"> <li>• High inertias due to high floating mass. Leads to low printing accuracy.</li> <li>• Works well with flexible materials.</li> <li>• Performance problems due to high temperatures at the motor.</li> </ul>	<ul style="list-style-type: none"> <li>• Low inertias resulting in high printing accuracy.</li> <li>• Problems with flexible materials if the pushing force is low.</li> <li>• Motor separated from the hotend, so no problems associated with temperature.</li> </ul>

### Which extruder may fit you better?

Just as with hotends, we do recommend to use extruders built by reliable manufacturers to ensure that printing parameters calculated in the software will be fulfilled during the print. If you are planning to print with flexible materials, make sure that the printer has enough pushing force to properly extrude the filament. You should also ask for the flexible materials that the specific printer is compatible with.



# 3D Printing Basic Concepts

## 2.6 Dual extrusion

### What is dual extrusion?

Dual extrusion refers to the ability of an FFF 3D printer to use two different filaments in a single print job.

### What influence have in the printer?

This technology allows a printer to use two different types of filament. The print combinations are:

- Multi-colour: Mixing two different colours of the same material.
- Multi-material: Work with two different materials in a single print.
- Soluble supports: Using dissolvable supports for complex geometries.
- Duplication and mirror: Duplication Mode prints the same model with both toolheads simultaneously (this doubles the printing capacity), while Mirror Mode prints the model and its symmetrical part at once (increasing iteration speed and shortening design times).

Dual Extrusion allows users to produce more complex parts using dissolvable supports and combine materials to obtain different mechanical properties and colors in one single print.

There are two types of Dual Extrusion in the 3D Printing Market:

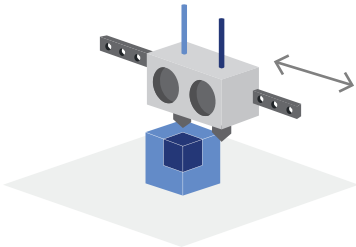
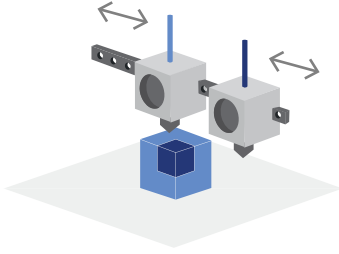
 <p><i>Parallel</i></p>	 <p><i>Independent Dual Extruder (IDEX)</i></p>
<p>Two print heads placed together in the same carriage.</p>	<p>Two print heads moving independently in the X-axis.</p>
<p>Regular Dual Extrusion Architecture</p>	<p>Advanced Dual Extrusion Architecture</p>
<ul style="list-style-type: none"> <li>• Since it is close to the part that is being printed, the inactive nozzle can <b>drop molten plastic</b> while waiting.</li> <li>• The <b>high mass</b> of two print heads implies <b>high inertias</b> when moving at high speed from one point to another, which leads to <b>less accuracy</b>.</li> <li>• <b>Standard production potential</b>. The two print heads are driven by the same motor, only one part at a time can be printed.</li> </ul>	<ul style="list-style-type: none"> <li>• There is <b>no cross-contamination between materials</b> as the idle print head remains parked, preventing the dripping of molten plastic into the part.</li> <li>• Reduces the floating mass, which <b>increases the printer's accuracy</b>.</li> <li>• <b>High production potential</b>. Since there are two independent Extrusion Systems, the printer has the production capability of two machines by printing with the 2 heads simultaneously.</li> </ul>

## 3D Printing Basic Concepts

### Do you need dual extruders?

Having two extruders allows a more efficient print, as it will give the user the power of dual versatility in one machine. While some dual printers may have the ability to print with dual products, colors or properties, some printers on the market may also use the dual extrusion to produce double amount of pieces (printing on mirror mode, for example). If you are planning to print with at least two materials, colors, or want to improve your performance, consider choosing a printer with dual extruders, or even better: with dual, independent extruders.

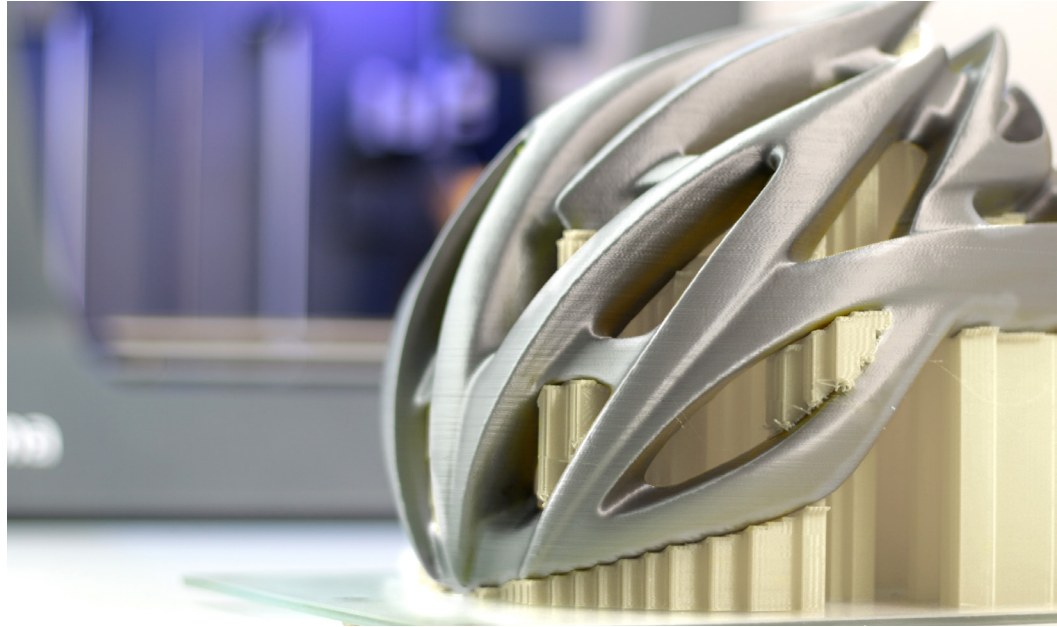

### 2.7 Printing speed

#### What is the printing speed?

The printing speed is the speed of the print head at which the deposition of molten material occurs.

#### What influence has in the printer?

Printing speed will have a direct influence on the quality of the printed part. The slower the speed, the better result: greater detail level and smooth surface quality on the end product. For this reason, printing speed is radically important when printing large models, as it may directly affect the quality of the end result. It is important to keep in mind that the speed parameter must always be concordant with the flow passing through the hotend.



#### Which printing speed may fit you better?

3D printers in the market offer a variety of print speeds. Generally speaking, speeds can be grouped into three levels:

- Slow print speed: 10 to 30mm/s
- Medium print speed: 30 to 60mm/s
- Rapid print speed: 60 to 100mm/s

Versatile machines in terms of speed favour businesses with multiple printing needs.

### 2.8 Compatible materials

#### What is a compatible material of a 3d printer?

A compatible material is a filament that would be printable in a determined machine. FFF 3D Printers accept a wide range of thermoplastic materials. The most common materials in FFF technology are PLA, ABS, PETG, Nylon, TPU, PC, HIPS, ASA, PP, PEEK, ULTEM and PVA.

#### What influence has in the printer?

In FFF 3D printing, choosing the right filaments is vital, as material requirements may vary depending on the use of the final print. Additionally, materials do require configuration and this configuration may vary. Finally, some printers cannot be configured for certain materials that are otherwise available in the market. It is for this reason that checking on compatible materials is a relevant indicator to look into when looking for 3D printers.

The most commonly used material in FFF 3D printers is PLA. This material has a wide range of applications, has a simple configuration and is widely compatible with most 3D printers in the market.

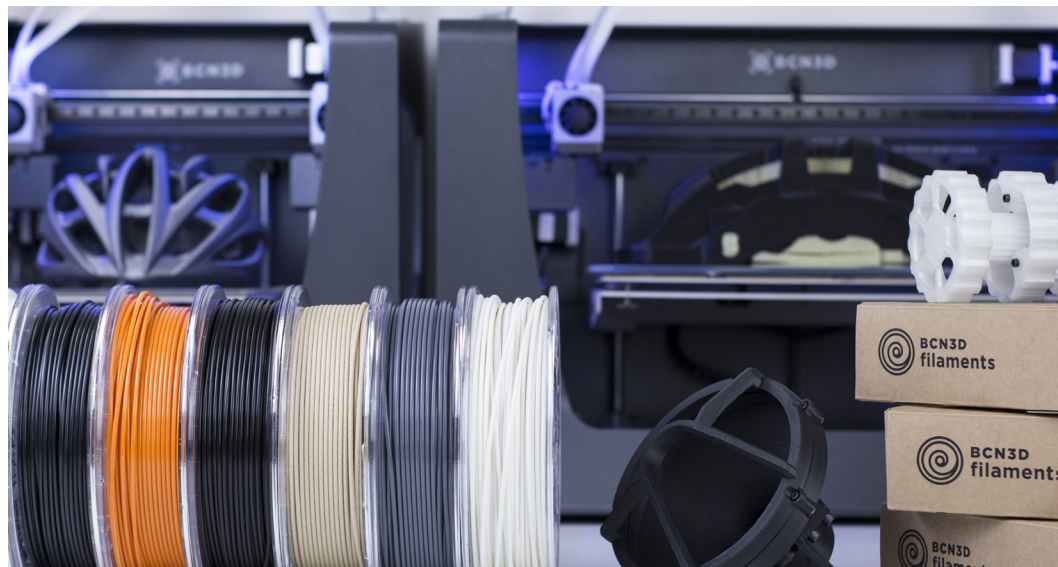

#### Which compatible materials may fit you better?

Users must ensure that the filaments they are planning to use in their print are accepted by the machine. This means that the printer can reach the melting temperature of the filament. Some manufacturers only accept their own brand filaments as a way to guaranteeing good results, albeit effectively reducing the range of possibilities. However, some printers accept filaments from any brand and offer more printing versatility.



### 2.9 Print surface

#### What is the print surface?

The print surface is the surface in which the first layer of a print job adheres.

Print surface materials and sizes have grown exponentially in the last few years, and currently, there is a large selection of print surface combinations available.

#### What influence has in the printer?

The print surface determines the level of adhesion during the print.

A major concern when printing is to avoid warping on materials such as ABS or Nylon:

- Use a heated print surface: this helps keep the material flat on the print surface, as heat relieves internal stresses.
- Always have a correct Surface Calibration: a bad calibration may cause the filament to detach from the print surface if the nozzle is printing too far from the surface.
- Use adhesives or high-adhesion printing surfaces.

#### Which print surface may fit you better?

Print surfaces have several features depending on the materials they are built from. For example, some printers offer an automatic or semi-automatic calibration of the surface, which eases the process and saves a lot of time. Also, a good print surface must ensure the correct adhesion of filaments.

Some popular materials are:

- Glass: with a high heat transference, and combined with adhesive, ensures a solid adherence. This material is rarely damaged when removing printed parts. It is also easy to clean.
- Kapton: this material offers even heat distribution throughout the surface. This surface maintains the first layer of print solidly in place even without adhesives. It may be damaged when removing printed parts.
- BuildTak: a versatile printing surface that must be combined with adhesives. Easy to use and replace.
- Garolite: a fiberglass/epoxy laminate that ensures the perfect adhesion for Nylon filaments. It doesn't require a heated surface or to use adhesives.



## 3D Printing Basic Concepts

### 2.10 Firmware

#### What is the firmware?

Firmware is the permanent software loaded into the 3D printer. It controls the electronic circuits of it.

#### What influence has in the printer?

These are a few elements that will help you identify how firmware has a positive effect on the machine and will improve overall the user experience:

- User-friendliness. This shows how easy the level of interaction between the user and the machine is.
- Notifications. Some printers will notify you on some occasions, key moments or milestones. For example, a machine can notify you regarding maintenance, failure prevention and assisted processes such as loading filaments or calibrating the machine.



#### Which firmware may fit you better?

For beginner users, it is always recommended to manipulate a machine with an intuitive firmware already installed that would allow users to complete basic functions and wouldn't require technical knowledge.

## 3D Printing Basic Concepts

### 2.11 Slicing software

#### What is the slicing software of a 3d printer?

The slicing software is a computer software used in FFF 3D printing processes for the conversion of a 3D object model into a specific set of instructions for the printer.

#### What influence has in the printer?

A slicing software instructs the printer with the information required for the print job, such as printing temperature or printing speed. The software converts your 3D model into layers that later sends to the printer in a file format the firmware understands. Some softwares account for pre-loaded profiles that allow you to print with preset requirements for certain materials, while others also include manual option that would allow the user to input information print settings.

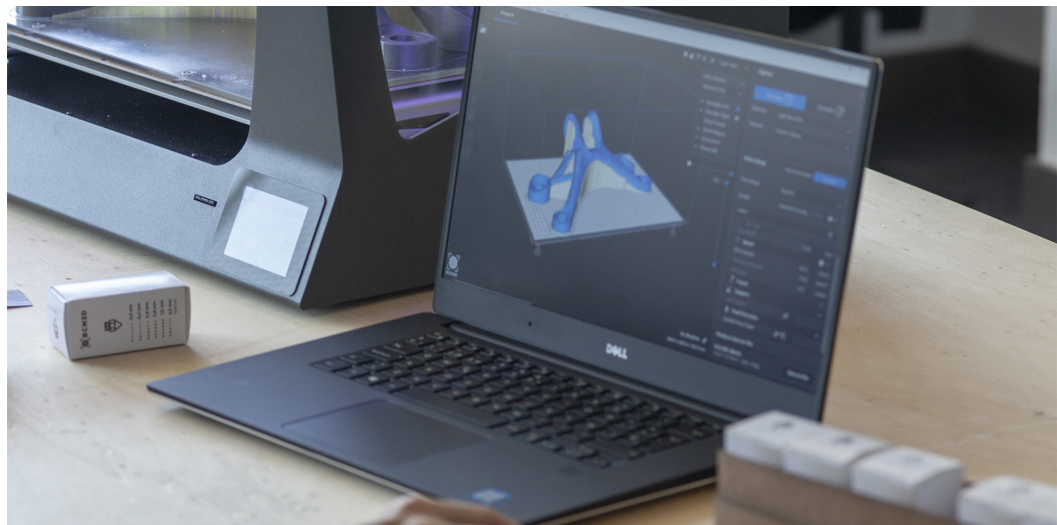

#### Which software may fit you better?

Sometimes printer manufacturers offer their own slicing software. However, users are normally free to use the software they want to interact with. The two most important slicing softwares are Cura and Simplify3D. Cura is free and has options for inexperienced and professional users. Simplify3D is also a versatile and professional option for preparing printing files.

The slicing software will take into account the capabilities of the 3D printer. For example, it will need to receive instructions on whether the printer uses dual extrusion, materials to be used and even the machine's brand.







# 03





## Conclusions

Currently, the market of 3D printers offers a wide range of capabilities and requirement ranges, and it can be at times overwhelming. This whitepaper should have covered all the important features that may differentiate all printers available in the market and answer all initial questions when facing the task of choosing a 3D printer. Matching your own company's goals, needs and priorities will help you narrow the search and choose a 3D printer that fits your corporate needs.

Generally speaking, versatile machines that offer multiple options on one or every aspect in this list will favor businesses with multiple printing needs.

<b>Build Volume</b>	 <ul style="list-style-type: none"><li>• Select a low or regular build volume if you are printing regular size pieces. Most 3D printer users don't need a large build volume.</li><li>• Select a large build volume if you are planning on printing large volume pieces. These machines tend to be more expensive than their smaller counterparts.</li></ul>
<b>Best Layer Resolution</b>	 <ul style="list-style-type: none"><li>• If you are aiming at high resolution, select a smaller height between layers.</li><li>• If you are aiming at speed, select the widest height.</li></ul>
<b>Hotend</b>	 <ul style="list-style-type: none"><li>• If you are aiming at high resolution, select a smaller nozzle size.</li><li>• If you are aiming at homogeneous printing, select a hotend made of good components, as this will ensure even heat distribution.</li></ul>
<b>Extruder</b>	 <ul style="list-style-type: none"><li>• If you want larger printing accuracy, choose bowden extrusion.</li><li>• If you will mainly print with flexible materials, choose direct extrusion.</li></ul>
<b>Dual Extrusion</b>	 <ul style="list-style-type: none"><li>• If you are aiming at simple prints, then select a parallel dual extruder.</li><li>• If you are aiming at using multi-materials creations with a clean execution, then select a machine with IDEX system.</li></ul>

## Conclusions

<b>Printing Speed</b>	 <ul style="list-style-type: none"><li>• If you would like to obtain quick renderings, then select higher printing speeds.</li><li>• If you would like to achieve higher quality on your printed pieces, then select lower printing speeds.</li></ul>
<b>Compatible Materials</b>	 <ul style="list-style-type: none"><li>• You will have more 3D printer options available if you are planning to print only with PLA.</li><li>• If you are planning on using a wide range of materials, then you will find fewer options in the market.</li></ul>
<b>Print Surface</b>	 <p>You can choose the temperature and materials of your print surface:</p> <ul style="list-style-type: none"><li>• If you are looking to prevent warping, use a heated surface, as well as adhesive or highly adhesive surfaces.</li></ul>
<b>Firmware</b>	 <ul style="list-style-type: none"><li>• If you are a beginner user, it is easier to manipulate an intuitive firmware.</li><li>• If you are familiar with 3D printing machines, then a more complex firmware will give you greater control over the machine and the ability to further tailor your prints.</li></ul>
<b>Slicing Software</b>	 <ul style="list-style-type: none"><li>• If you select a 3D printer that comes with its own slicing software, then the set up will be a little easier since you will have pre-loaded specifications appropriate for that printer model.</li></ul>

When choosing a 3D Printer make sure to ask all these features to the printer's manufacturer and check they will fit your requirements. If you want to know more information about the influence of these features on a FFF 3D Printer, contact us at [info@bcn3d.com](mailto:info@bcn3d.com).

---

# Maximizing productivity with the most versatile 3D printers

If you are considering implementing 3D printing technologies into your workflow, ask for a BCN3D Sample Part in the following link in order to see the results of a professional FFF 3D Printer [Request a Free sample >](#)

Explore more about 3D printing. [Learn more >](#)

Wondering what's new in the 3D printing world? [Use Cases >](#)

Request a quote for a professional desktop 3D printer. [Request a quote >](#)

